

PRODUCT BROCHURE

Custom Thoraflex™ Hybrid

Experience Optimised Intervention

Tailored Solutions Adapted for Patient Needs

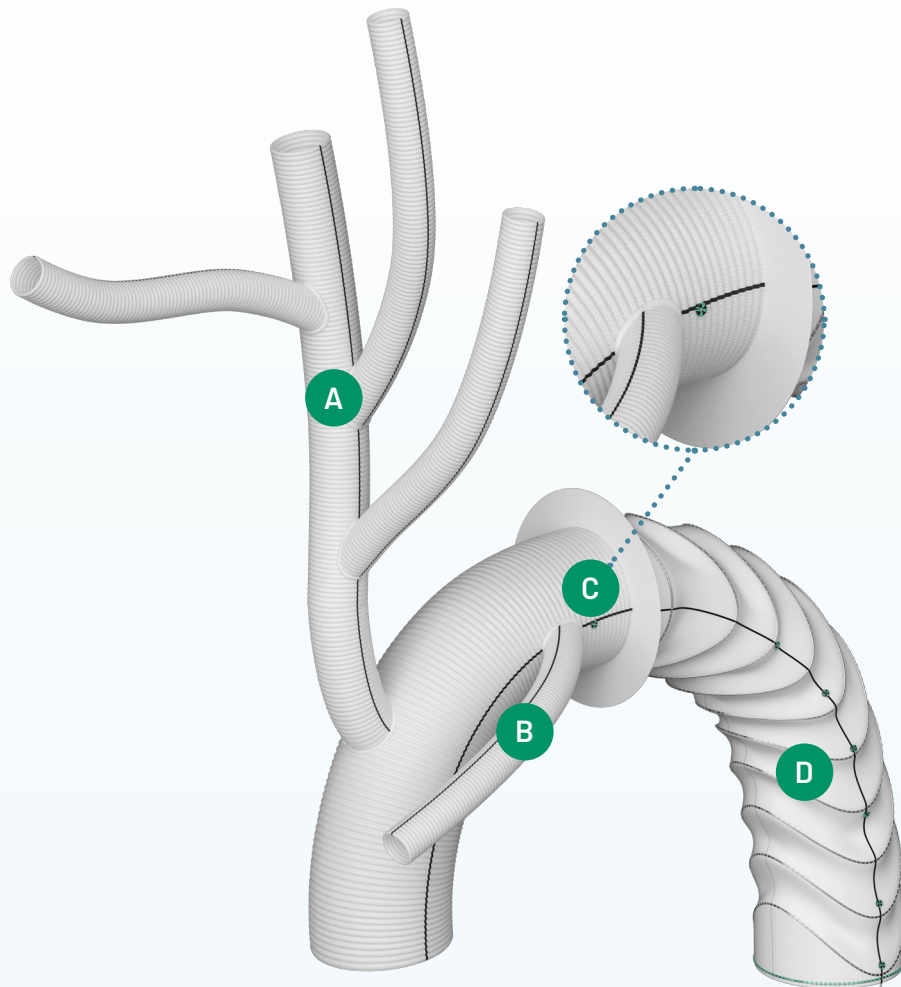

“A modification to the standard Thoraflex Hybrid design allowed **improvement in operating times**, complete and continuous cerebral trivascular perfusion, and **correct positioning of the intrathoracic vessels.**”¹



WATCH ON VUMEDI
The Worlds First Custom Thoraflex Hybrid FET Device Case Report

Custom Options

A GRAFT OPTIONS Arch Branches

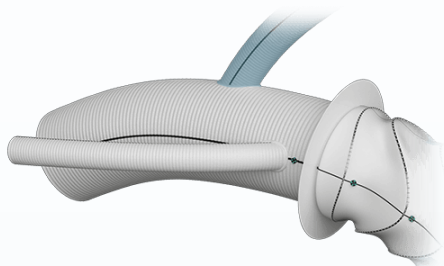

- ▶ 0-7 main branches (including bifurcate/side branch)*
- ▶ Adjusted angles, positioning and spacing*
- ▶ Diameters of 8/10/12/14/16/18mm*
- ▶ Lengths up to 150mm*

B GRAFT OPTIONS Side Branch

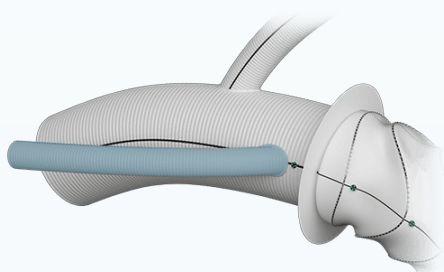

- ▶ Adjusted angle and orientation*
- ▶ Diameter 10mm
- ▶ Length 150mm

C GRAFT OPTIONS Radiopaque Markers

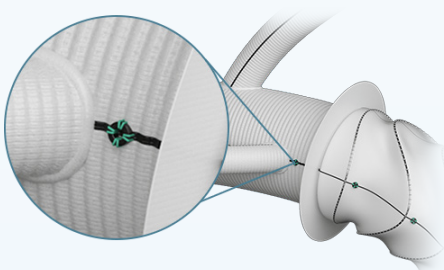

- ▶ Maximum of 2 (main body)
- ▶ Flexible positioning*

D STENT OPTIONS Stent Configurations

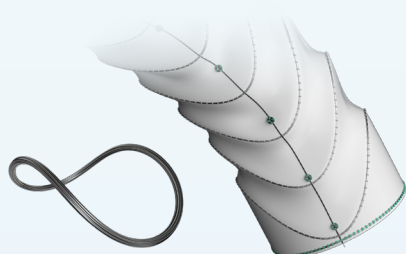

- ▶ Extra offset 10° Mid-rings (increased radial force)
- ▶ Shorter stent (60mm minimum length)
- ▶ Combination of the two

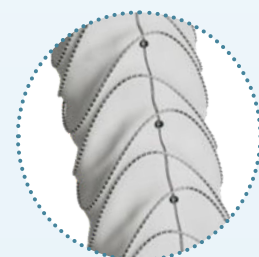
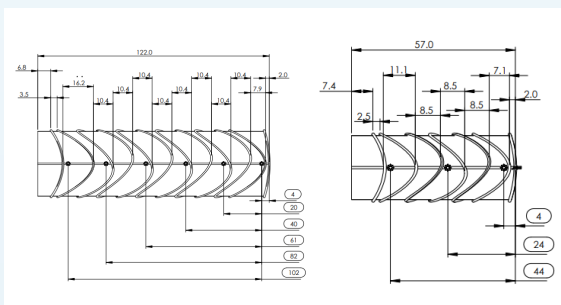

Committed to Aortic Care



Discover solutions for every segment of the aorta
terumoortic.com



Custom Solutions

View IFU at ifu.terumoortic.com for more information on use, indications, contraindications and warnings/precautions.

Custom made devices are specifically made in accordance with a written prescription of any person authorised by national law by virtue of that person's professional qualifications; which gives (1) specific design characteristics provided under that person's responsibility and (2) is intended for the sole use of a particular patient exclusively to meet their individual conditions and needs. Custom made devices are not available in the US and availability is subject to local regulatory approval.

PM-08587

For distributor information, visit
terumoortic.com/contact

 Vascutek Ltd.
Newmains Avenue, Inchinnan,
Renfrewshire PA4 9RR, United Kingdom

